

# NODE



ENG

**NEW**

**Battery-Operated Controller**  
Owner's manual and programming instructions

**Hunter®**

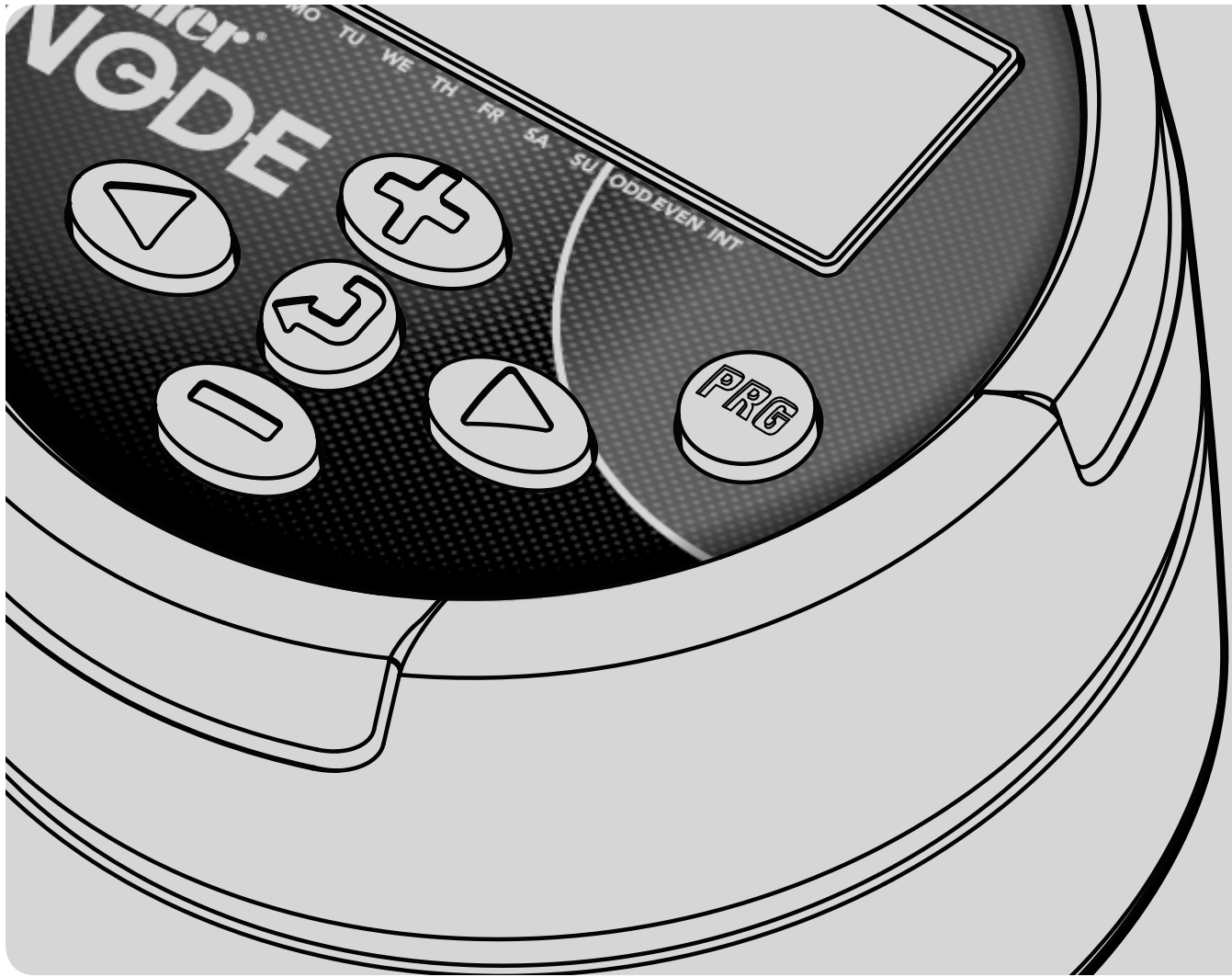

# TABLE OF CONTENTS

ENG

|   |    |                                     |    |
|---|----|-------------------------------------|----|
| <b>NODE FEATURES</b> .....  | 2  | <b>BATTERY LIFE INDICATOR</b> ..... | 14 |
| <b>NODE COMPONENTS</b> .....  | 3  | <b>RESETTING CONTROLLER</b> .....   | 14 |
| Control Buttons   |    | <b>TROUBLESHOOTING GUIDE</b> .....  | 15 |
| LCD Display   |    | <b>SPECIFICATIONS</b> .....         | 16 |
| <b>CONNECTING THE BATTERY/BATTERIES</b> .....                           | 4  | <b>NOTES</b> .....                  | 17 |
| <b>ATTACHING SOLENOIDS</b> .....  | 5  |                                     |    |
| To Wire DC Solenoids to the NODE  |    |                                     |    |
| To Mount the NODE to a Valve (Figure 1)                                 |    |                                     |    |
| <b>MOUNTING THE NODE</b> .....  | 6  |                                     |    |
| <b>CONNECTING A WEATHER SENSOR</b> .....                                | 6  |                                     |    |
| Setting the Date and Time   |    |                                     |    |
| <b>IDLE MODE</b> .....  | 7  |                                     |    |
| <b>RUN MODE</b> .....   | 7  |                                     |    |
| <b>PROGRAMMING</b> .....  | 7  |                                     |    |
| Setting Watering Start Times  |    |                                     |    |
| Setting the Run Times   |    |                                     |    |
| Setting Watering Days   |    |                                     |    |
| Selecting Odd/Even Days to Water  |    |                                     |    |
| Selecting Interval Days to Water  |    |                                     |    |
| Setting the Seasonal Adjustment   |    |                                     |    |
| Turning the System Off  |    |                                     |    |
| Manual Watering   |    |                                     |    |
| Sensor Operation  |    |                                     |    |
| <b>ADVANCED PROGRAMMING FEATURES</b> .....                              | 12 |                                     |    |
| Sensor Bypass   |    |                                     |    |
| Easy Retrieve Memory  |    |                                     |    |
| Setting Master Valve Operation (NODE-200, NODE-400,<br>& NODE-600 only) |    |                                     |    |
| Programmable Off (up to 99 days)  |    |                                     |    |
| Hunter Quick Check  |    |                                     |    |

# NODE FEATURES

---

- Simple push button programming
- Single station model with DC latching solenoid. 2,4, or 6 station models also available (solenoids not included).
- Large Liquid Crystal Display (LCD) with easy to understand icons
- Operates on a standard 9-volt alkaline batteries (1 or 2 for extended battery life)
- 3 programs (A, B, C) with up to 4 start times each
- Run times from 1 min to 6 hours
- Manual watering
- Battery Indicator shows remaining life of battery
- Rain sensor compatible
- Non-volatile memory retains all program information
- Seasonal Adjustment from 10–150%
- Easy Retrieve Memory allows saving/retrieval of preferred program data
- Manual Bypass of Rain Sensor
- Total Run Time Calculator shows total program irrigation time per program

# NODE COMPONENTS

This section provides a brief overview of some of the components of the NODE. Each item will be discussed in further detail later. However, this section can be helpful in getting acquainted with the different options available.

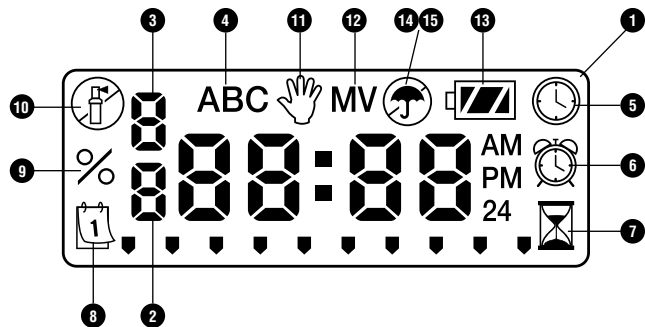

## Control Buttons

1. **➔ Button** – Increases the selected flashing display
2. **➜ Button** – Decreases the selected flashing display
3. **↻ Button** – Selects programming function
4. **▶ Button** – Advances the selected flashing display back to the next item
5. **◀ Button** – Navigates the selected flashing display back to the previous item
6. **Ⓜ Button** – Selects the program (A, B, or C)

## LCD Display

1. **Main Display** – Indicates all program information
2. **Station Number** – Indicates the station number being programmed
3. **Start Time Number** – Indicates the start timer number being programmed
4. **Program** – Indicates the program (A, B, or C)
5. **⌚ Current Time/Day** – Indicates when current day/time is being set
6. **⌚ Start Times** – Indicates when start times are being set
7. **⌚ Run Times** – Indicates when Run Times are being set. Allows user to set run times from 1 minute to 6 hours.
8. **📅 Watering Days** – Allows the user to select individual days to water or a selected number of days between watering (interval)
9. **% Seasonal Adjustment** – Allows the seasonal adjustment to be programmed from 10–150% (default value is 100%)
10. **🛑 System Off** – Indicates that watering is suspended
11. **👤 Manual On/Off** – Indicates when manual watering is programmed. Allows the user to activate the station manually.
12. **MV** – Indicates that station one is set to master valve operation (only available on 2,4, or 6 station models)
13. **🔋 Battery Status** – Indicates remaining battery life
14. **☂ Umbrella** – Indicates the rain sensor is suspending irrigation
15. **☂ Crossed Umbrella** – Indicates the rain sensor has been manually bypassed

# CONNECTING THE BATTERY/BATTERIES

The NODE uses two standard 9-volt batteries (not included) to operate the valves and program the controller. The controller can operate using either a single 9-volt battery or using two 9-volt batteries. Under normal conditions, the expected life is 1 year for a single battery and two years when using two 9-volt batteries.



**NOTE:** The NODE has non-volatile memory which allows for the battery to be removed without losing program information.

## To Install the Battery/Batteries

1. Unscrew the rear body of the NODE body to gain access to the battery compartment.
2. Insert the battery/batteries into the battery tray and connect to the controller using the battery connector.
3. Make sure that no water is inside the battery compartment.
4. Screw the NODE rear body back onto the front half.



**NOTE:** Make sure that the seal marker on the rear half of the NODE lines up with the front half, ensuring that a proper seal is created.

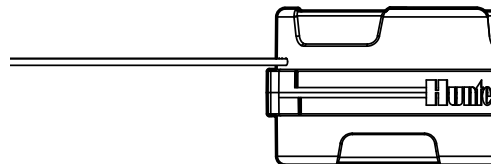
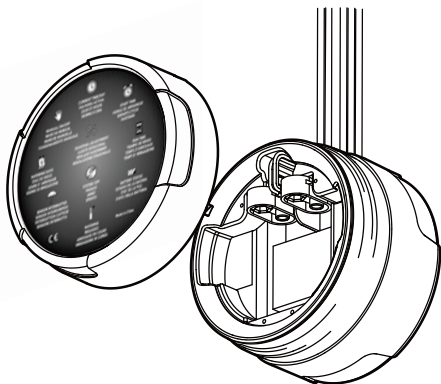

# ATTACHING SOLENOIDS

The NODE-100 is provided with a solenoid attached to the controller. The NODE-200, NODE-400, and NODE-600 multi-station controllers will operate up to 2, 4, or 6 solenoids, respectively. Hunter DC solenoids (P/N 458200) can easily be installed on all Hunter Plastic Valves.



**NOTE:** Must use DC Latching Solenoids operating between 9-11VDC. 24VAC Solenoids will not operate with the NODE.

## To Wire DC Solenoids to the NODE

1. Attach the black leads from each solenoid to the single common wire (black lead) coming from the NODE. Secure all wire connections with waterproof connectors.
2. Attach one red wire from each solenoid to the corresponding station wire (red lead) from the NODE. The station numbers are identified on the face of the NODE. Secure all wire connections with waterproof connectors.



**NOTE:** The maximum wire distance between the solenoid and NODE is 100 ft/30 m (18 gauge minimum wire size).

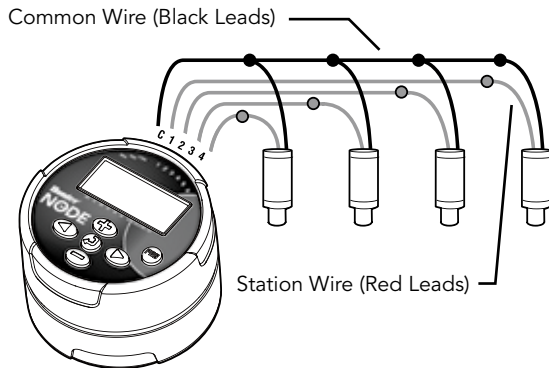

## MOUNTING THE NODE

The NODE can easily be mounted on any Hunter plastic valve. A specially designed valve mounting clip makes installation a snap. A protective rubber cover is provided to prevent dirt from accumulating on the face of the NODE.

### To Mount the NODE to a Valve (Figure 1)

1. Unscrew the existing solenoid from the valve.
2. Screw the Hunter DC latching solenoid (P/N 458200) into the valve bonnet.
3. Attach the large end of the valve mounting clip to the middle of the NODE body.
4. Snap the small end of the valve mounting clip to the solenoid.

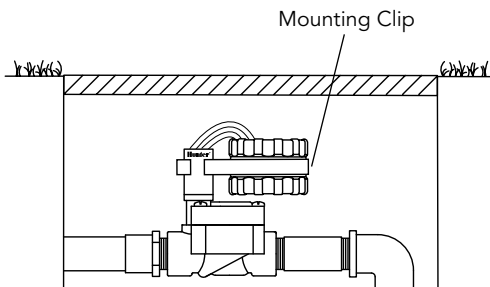

Figure 1

## CONNECTING A WEATHER SENSOR

A Hunter Mini-Clik® or Rain-Clik® rain sensor can be connected to the NODE. The purpose of this sensor is to stop watering when weather conditions dictate.



**NOTE:** When the Rain Sensor is interrupting the watering, the display will show the System Off icon (🚫), "OFF" and 🌧️ on the display.

1. Cut the yellow wire loop attached to the NODE at approximately the middle of the loop.
2. Remove approximately ½" (13 mm) of insulation from each wire. Attach one yellow wire to each of the wires of the weather sensor. You can mount the rain sensor up to 100 ft (30 m) from the NODE controller (18AWG/1.0 mm minimum wire size).
3. Secure wire connections with waterproof connectors.

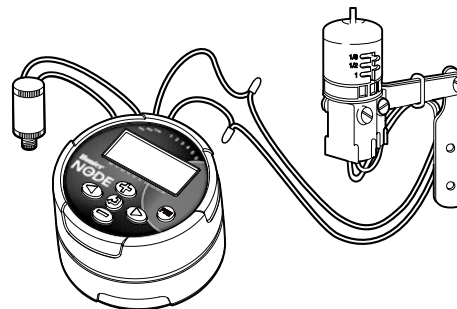

Hunter Model Mini-Clik®

## IDLE MODE

---

Normally the NODE display shows the time and day, day of the week, MV (if master valve option is activated) and the battery life indicator. During a short period of inactivity the display will shut off to retain battery power. Pressing any button will wake up the NODE to the Idle Mode.

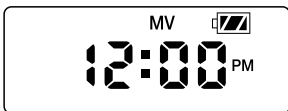

## RUN MODE

---



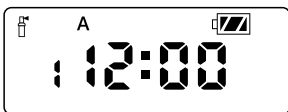

When the controller is operating a program the items shown on the display will include the station number, program letter, remaining runtime, and the blinking Rotor icon.



## PROGRAMMING







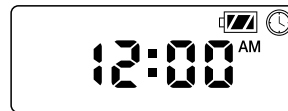







---

ENG

The NODE uses standard Hunter controller programming with 3 programs (A, B, C) and 4 start times per program. On standard Hunter controllers a dial is used to scroll between the programming functions, however, on the NODE the  button is used to quickly and easily create the irrigation program. When programming, the flashing portion of the display can be changed by pressing the  or  buttons. To change something that is not flashing, press the  or  buttons until the desired item is flashing.









### Setting the Date and Time

1. Push the  button until the  icon is displayed.
2. All 4 digits will be displayed representing the year. Use the  or  buttons to change the year. Press the  button to proceed to setting the month.
3. All 4 digits will be displayed with the two digits on the left representing the month flashing. Use the  or  buttons to change the month. Press the  button to proceed to setting the day.
4. Only the two digits on the right side will be displayed and flashing, representing the day. Press the  or  button to change the day. Press the  button to proceed with changing the hour. Press the  button to proceed to setting the time.
5. The AM/PM/24 time setting is shown flashing. Press the  or  button to change the time setting to AM, PM, or 24-hour time. Press the  button to proceed to setting the hour.







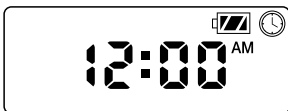

## PROGRAMMING (CONTINUED)

ENG

6. All 4 numbers are shown with the two numbers on the left flashing, representing the hour. Use the  or  buttons to change the hour. Press the  button to proceed to setting the minutes.
7. All 4 numbers are shown with the two numbers on the right flashing, representing the minutes. Use the  or  buttons to change the minutes. Pressing the  button will advance to the year setting at step #2.
8. Press the  button to proceed to the next programming function or allow controller to return to idle mode.



### Setting Watering Start Times





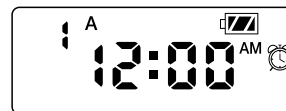

1. Press the  button until the  icon is displayed.
2. The start time will be displayed flashing, along with the program letter (A, B, or C) and the active station # on the lower left side of the display. Press the  or  button to change the station run time from 1 minute to 6 hours.
3. Use the  or  buttons to change the start time for the program that is displayed. Each press of the button will change the start time in 15 minute increments.
4. Press the  button to add an additional start time to the program displayed. The start time number is shown in the upper left corner of the display.
5. Press the  button to add start times to a different program.

6. Press the  button to proceed to the next programming function or allow controller to return to idle mode.









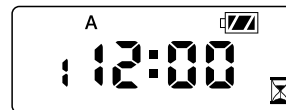

**NOTE:** After programming the run time for the last station press the  button to display the total run time for the program.

### Setting the Run Times

1. Press the  button until the  icon is displayed.
2. The run time will be displayed flashing. Also shown is the program letter (A, B, or C) and the active station # on the lower left side of the display. Press the  or  button to change the station run time from 1 minute to 6 hours.
3. Press the  button to advance to the next station.
4. Press the  button to add a run time to another program.
5. Press the  button to proceed to the next programming function or allow controller to return to idle mode.





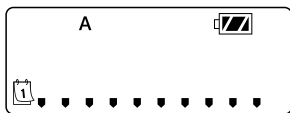

## Setting Watering Days

1. Press the  button until the  icon is displayed.
2. The program letter (A, B, or C) will be displayed.
3. Arrows point at the specific days of the week in which watering will occur. Press the  or  buttons to scroll through the days.
4. Press the  button to activate that day for the program displayed, or the  button to cancel watering for that day. **The arrow will show on the watering days for the active program.**
5. Press the  button to set days to water for a different program, if desired.
6. Press the  button to proceed to the next programming function or allow controller to return to idle mode.



## Selecting Odd/Even Days to Water





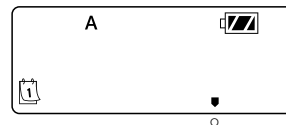

This feature uses numbered days of the month for watering instead of specific days of the week.

1. Press the  button until the  icon is displayed.
2. Press the  button until the cursor is above either ODD or EVEN on the display.
3. Press the  button to select, or the  button to cancel either ODD or EVEN days to water.

4. Once ODD or EVEN mode is activated it will be the only cursor shown on the display.



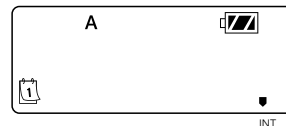

## Selecting Interval Days to Water

1. Press the  button until the  icon is displayed.
2. Press the  button until the cursor is above **INT** on the display.
3. Press the  button and a 1 will be flashing indicating the number of days between watering.
4. Press the  or  button to select the number of days between watering days (1 to 31).



## Setting the Seasonal Adjustment

1. Press the  button until the **%** is displayed.
2. Press the  or  button to increase or decrease the seasonal adjustment value from the default 100% (down to a minimum of 10% or a maximum of 150%).
3. The value programmed for seasonal adjustment will be applied to all irrigation programs and will immediately be reflected in



## PROGRAMMING (CONTINUED)

ENG

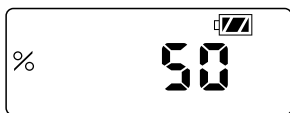
the run times displayed. Example, if 20 minute run times are programmed and then the seasonal adjustment is changed from 100% to 50%, the run times displayed will be 10 minutes.





### Turning the System Off

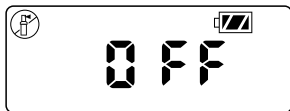







To turn your controller off, press the  button until the  icon and **Off** is displayed on screen. To return the controller to auto programming mode, press the  button. The controller will immediately return to auto programming mode and will display the time and battery life indicator.



### Manual Watering





Manual Watering allows the user to test each station or a program for a specified run time. The weather sensor condition (if used) will be disregarded in this mode.

1. Make sure the controller is in Idle Mode. Press and hold the  button until the  icon is displayed.
2. The station number will be displayed in the lower left side of the display along with the run time.

3. Use the  and  buttons to select the desired station and the  and  buttons to set the manual watering time for the station shown.
4. To manually activate a program, press the  button. The program letter (A, B, or C) will show on the screen. If a different program is needed, press the  button until the desired program is displayed.
5. To stop the Manual watering cycle press the  button until the time is reduced to zero.
6. Press the  button to proceed to the next programming function or allow controller to return to idle mode.



#### NOTE:

- Pressing the  or  buttons when a station in running in manual watering will modify the irrigation time for that station.
- Pressing the  button when a station is running in manual watering will stop irrigation on the current station and advance to the next station.
- Pressing the  button when a station is running in manual watering will stop the irrigation on the current station and revert to the previous station.

### Sensor Operation

The NODE is compatible with the Hunter Clik rain sensors including Mini-Clik® and Rain-Click®, as well as many other interrupt type devices/sensors that do not require power. Simply connect the sensor to the NODE controller by cutting the yellow wire loop and connecting to the sensor wires.



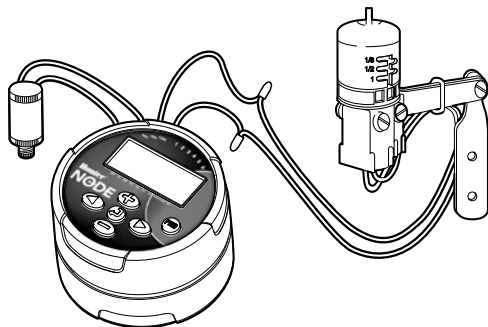

**NOTE:** NODE is not compatible with Hunter Wireless Rain-Clik® or other weather devices that require 24VAC power.

When the sensor is activated it will suspend irrigation and the ☂ icon will show on the display.





All advanced programming functions are initiated from the Idle Mode, which shows the time, day of the week, and battery life indicator on the display. If something is flashing on the display then the controller is in one of the programming modes. After a short period of inactivity the controller will return to Idle Mode.

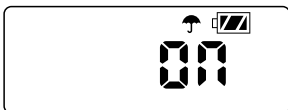

## Sensor Bypass

1. From the Idle Mode, press and hold the  button until the  icon is displayed.
2. The display will show the umbrella icon flashing and **On**.



3. Press the  button to bypass the sensor. The display will show  and **Off** indicating the weather sensor is bypassed. The  icon will show on the display during normal operation, indicating the controller is in bypass mode.





4. To reactivate the weather sensor press and hold the  button until the  icon is displayed. Press the  button to return to normal sensor mode.

## Easy Retrieve Memory



This function allows the user to save a preferred program to permanent memory in the controller, to be restored at any time. This is a great way to override changes made, and revert back to the original programming schedule .

To save a program:

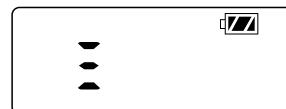
1. Make sure that the controller is programmed with the preferred programming schedule.
2. From the Idle Mode, press and hold the  and  button for 5 seconds to save the current program.
3. The screen will show 3 dashed lines moving from left to right indicating that the current program is being saved to permanent memory. The display will flash **Done** when the process is complete.



To retrieve a saved program:

1. From the Idle Mode, press and hold the  and  button for 5 seconds.
2. The screen will show 3 dashed lines moving from right to left indicating that the preferred program is being retrieved from memory.



The controller now has the preferred program as the current program. The display will flash **Done** when the process is complete.





**NOTE:** Be careful when using Easy Retrieve memory. Saving program data to memory using Easy Retrieve will take the current program information and override whatever is saved in permanent memory. When saving program data make sure that the current program data is what you want saved.

## Setting Master Valve Operation (NODE-200, NODE-400, & NODE-600 only)

The multi station NODE models (NODE-200, NODE-400, and NODE-600) are capable of being programmed with the use of a normally closed master valve. When programming with the master valve you will be assigning station 1 as the master valve, effectively losing the use of station 1 for activation of an irrigation station.

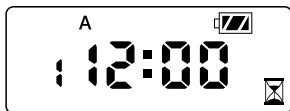
1. From the Idle Mode, press the  button until the  icon is displayed.
2. Program A will be displayed along with the active station # on the lower left. Make sure the active station showing is #1. The run time will be shown.





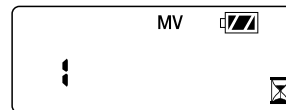

3. Press the  button once and the **MV** icon will display on the screen and the time will disappear. Station 1 is now acting as the master valve and will not be available in other programming screens.



4. When the master valve is activated it will apply to all programs and the **MV** icon will stay displayed on the screen at all times.





## Programmable Off (up to 99 days)

This feature permits the user to stop all programmed watering for the designated period from 1-99 days. At the end of the programmable off period the controller will resume normal operation.

1. From the Idle Mode, press the  button until the  icon is displayed. Wait two seconds until **Off** is shown on the display. The controller is now in System Off mode.
2. Press the  button and a 1 will be displayed blinking, indicating the number of days the controller will stay off. Program the off days as desired, up to 99 days maximum.
3. The display will show the number of days remaining in the OFF period.
4. To interrupt the OFF period press the  button to return to the Idle Mode screen, showing the time of day and day of the week.





## Hunter Quick Check

This circuit diagnostic procedure can quickly identify “shorts” commonly caused by faulty solenoids or when bare common wire touches a bare station control wire. To initiate the Hunter Quick Check procedure:

1. From the Idle Mode, press and hold the , , , and  buttons.
2. The display will show all segments. Release the buttons.
3. Press the  button to initiate the Quick Check test.
4. The controller will then activate each available station for 1 second until all stations have been activated.







## BATTERY LIFE INDICATOR

The remaining battery life can be estimated from the battery life indicator shown on the display. The NODE can operate using either a single 9-volt battery or using two 9-volt batteries. Using two nine volt batteries will yield approximately twice the battery life of a single 9-volt battery. The battery life indicator chart below shows an estimate on the remaining battery life.

-  Full: 100–60% remaining battery life
-  Med: 60–25% remaining battery life
-  Low: 25–0% remaining battery life
-  Replace battery immediately!

## RESETTING CONTROLLER

Resetting the controller will erase the current program data and restart the controller. A reset does not, however, delete a program saved to permanent memory using the Easy Retrieve Memory feature (see page 12) to save a preferred program.

1. From the Idle Mode, press and hold the , , and  keys.
2. After two seconds the screen will go blank. Continue to hold the , , and  keys.
3. 12:00 will flash on the display. Release the keys.
4. The controller may show a countdown from 10 to 1 on the display, and then 12:00 AM will be shown flashing when the reset is complete. The controller can now be reprogrammed.

# TROUBLESHOOTING GUIDE

ENG

| <b>Problem</b>  | <b>Causes</b>   | <b>Solutions</b>  |
|---|---|---|
| <b>There is no display.</b>                               | Display is off.<br>Battery is dead.   | Press any button for 1 second.<br>Replace the battery.  |
| <b>Display indicates watering but none is occurring.</b>  | No water pressure.<br>Faulty solenoid.<br>Incompatible solenoid.  | Turn on main system supply.<br>Replace solenoid.<br>Must use Hunter DC Latching Solenoid (P/N 458200) or other compatible DC latching solenoid. |
| <b>Automatic irrigation does not start at start time.</b> | Controller in System Off mode.<br><br>AM/PM of time of day not set correctly.<br>AM/PM of start time not set correctly. | Verify that controller is programmed for automatic watering.<br>Correct AM/PM of time of day.<br>Correct AM/PM of start time.                   |
| <b>Rain sensor does not suspend watering.</b>             | Rain sensor defective or miswired.  | Verify proper operation of the rain sensor and wire connections (see page 10).  |
| <b>Controller waters more than one time.</b>              | The program has more than 1 start time assigned to it. Each program has up to 4 start times.                            | Eliminate program start times as needed.  |

# SPECIFICATIONS

---

**Dimensions:** 3 ½"(89 mm) diameter, 2 ½"(64 mm) high

**Sensor inputs:** 1

**Power source:** 9-volt alkaline battery (1 or 2 for extended battery life)  
Activates DC latching solenoids operating 9-11VDC (Hunter PN 458200)

**Operating temperature:** 0°F to 140°F or -17°C to 60°C

## Approvals

IP68

CE

FCC

C-Tick



