

# RAIN BIRD®

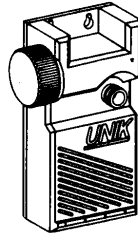

## UNIK One, Two and Four Station Control Module

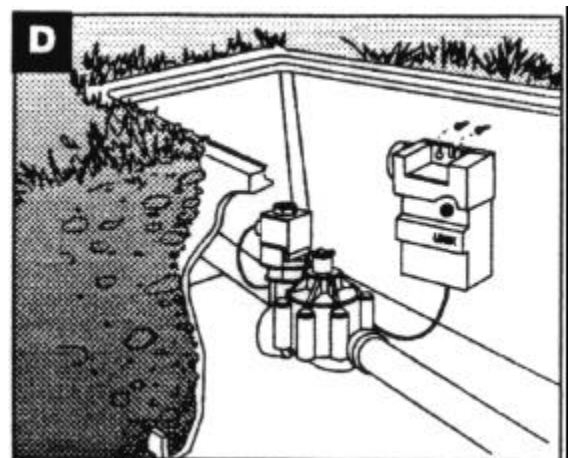
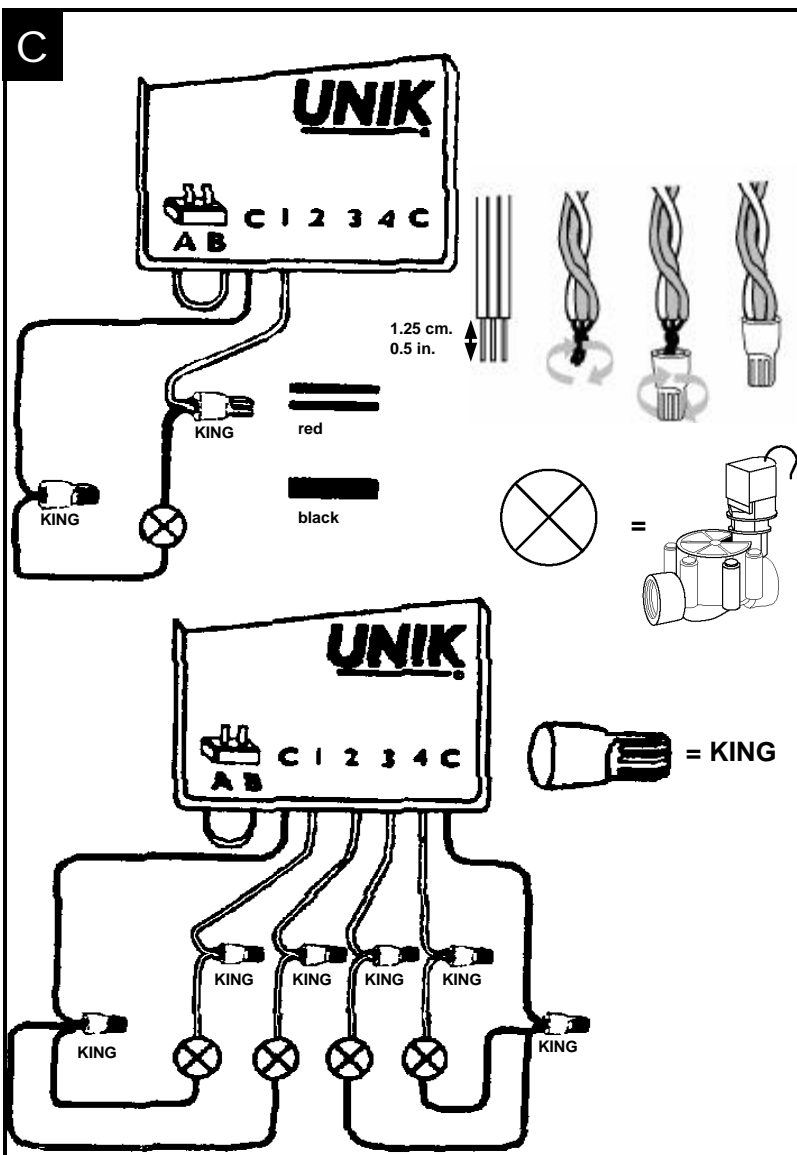
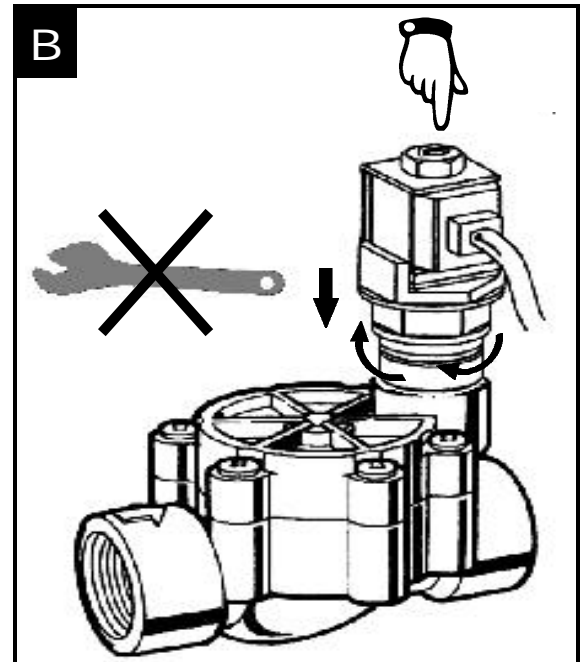
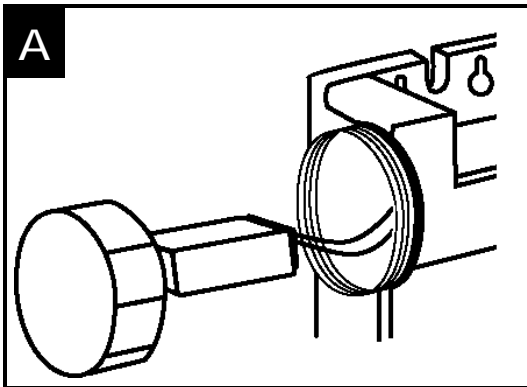

## Welcome to Rain Bird

The UNIK® One, Two, and Four Station Control Modules, part of the UNIK irrigation system family, store programming information and relay it to the solenoids.

The Control Modules allow:

- One minute to 12 hour irrigation run times per station in one minute increments
- Three independent programs: A, B, C
- Up to eight start times per program, per day
- Seven-day programming schedule calendar
- Manual irrigation start or stop capacity
- Infrared data transmission (even if the module is submerged in water)

The Control Modules operate within a 32° to 140° F (0° to 60° C) temperature range and up to 10 bars.

## Connecting the Control Module

### Installing the battery

The Control Modules are powered by a 9-volt alkaline battery (not included), type 6AM6 or 6LR61. We recommend you use a high-quality alkaline battery, such as Energizer. A high-quality battery will last up to one year.

To install the battery:

1. Unscrew the cap to the battery compartment.
2. Remove the small tube of grease from the battery compartment.
3. Remove the battery connector from the battery compartment. and
4. Follow the instructions on the tube to apply grease to terminals on the battery connector and battery.
5. Attach the battery to the connector and insert the connected battery into the battery compartment, **connector side first** (see fig. A).
6. Screw the cap back on to the battery compartment. Make sure the cap is tightened securely by hand to seal the compartment and prevent water from damaging the battery.

### Installing and connecting the DC latching solenoid

You must replace the existing solenoid on the valve with a UNIK DC latching solenoid.

To replace the solenoid:

1. Turn the water off.
2. Unscrew the existing solenoid from the valve.
3. Screw the DC latching solenoid onto the valve and gently tighten it by hand. Do not use a wrench or any other type of tool to tighten the solenoid. (See fig. B)
4. Turn the water back on.

To connect the DC latching solenoid to the Control Module, use the supplied wire connectors (the supplied wire connectors were changed from DBM wire connectors to King connectors in December 1997).

For King connectors:

1. Strip approximately 0.5 in. (1.25 cm.) of the insulation off the wires (see fig. C) and twist the wires together.
2. Push the twisted wires into a King connector and twist the connector to secure the wires. Gently pull on the wires to make sure they are secure.

If the wires slip out of the connector, get a new connector and repeat steps 1 and 2.

For DBM connectors:

1. Do not strip the wires. DBM wire connectors are designed to cut through the insulation to make a water resistant coupling without removing the insulation.
2. Push the wires all the way into the wire connector. Be sure to crimp the black cap all the way down (gel should ooze out of the top) to ensure a water-resistant connection. Gently pull on the wires to make sure they are secure.

If the insulation has been stripped, recut the wires and repeat steps 1 and 2.

**Important: The wire run between the Control Module and the solenoid must not exceed 32 ft. (10m).**

3. Check the system by using the manual start command on the UNIK Field Transmitter. If the irrigation system does not start, tighten the DC latching solenoid by hand.

## Mounting the Control Module

To mount the Control Module to the valve box:

1. Screw two mounting screws (not included) into the side of the valve box. (See fig. D)
2. Slide the Control Module's mounting key holes over the screws; press down to secure.
3. Tighten the mounting screws.

## Automatic Self-Cleaning Solenoid Plunger Feature

Every night at midnight, the Control Module sends a signal to the solenoid to turn it on and then off. This cycle lasts about three seconds. This preventative maintenance feature is intended to keep the solenoid plunger clean for maximum reliability.

## Maintaining the Control Module



To keep your UNIK Control Module in working order:

- Replace the battery once a year. We recommend you use a high-quality alkaline battery, such as Energizer.

## Maintaining the Control Module (Continued)

**Note:** If the Control Module battery is dead, any programs stored in the Control Module are lost. If the battery still has power, when you change the battery any stored programs will be lost within approximately two minutes.

To avoid this:

1. Connect the Field Transmitter to the Control Module.
  2. Press  to retrieve (upload) stored programs into the UNIK Field Transmitter.
  3. Change the battery and firmly hand tighten the battery compartment cap.
  4. Press  to transmit (download) the program into the Control Module.
- Make sure the optical connector is clean when you are transmitting data to the Control Module with the UNIK Field Transmitter or the UNIK PLIP. If necessary, clean the optical connector with water.

## Troubleshooting

The following list contains possible problems you may encounter and some solutions.

Most of the problems involving the UNIK Control Module can be classified as transmission / reception malfunctions usually caused by a dead or improperly connected battery. Other common causes of malfunction could be a dirty optical connector and poor wire connections.

These problems are easy to fix. If you experience transmission / reception problems, try using a Control Module that operates properly to determine if it is the Field Transmitter or Control Module that is the source of the problem.

Before calling Rain Bird, check the following list. If you cannot solve the problem yourself, call our Technical Service Hotline at 1-800-RAIN-BIRD (U.S.) or 626-963-9311



**Customer Support Center  
6640 S. Bonney Ave.  
Tucson, AZ 85706  
1-800-RAIN-BIRD  
(520) 434-6289 FAX**

**Troubleshooting Guide Begins On The Next Page.**

## Troubleshooting (Continued)

**Problem:**            **Faulty transmission**

*Possible cause:*    The microprocessor did not reset properly.

*Solution:*            Remove the battery. Short the Control Module battery clip (not the battery) contacts together with a paper clip or other piece of metal for 30 seconds. Reinstall a fresh battery.

*Possible cause:*    A wire connection is faulty.

*Solution:*            If you are using King wire connectors, gently pull on the wires to make sure they are secure. If the wires are loose, cut the wires. Strip 0.5 in. (1.25 cm.) of the insulation off the wires. Twist the wires, then push the wires into a new King connector and twist the connector around the wires. Gently pull on the wires to make sure they are secure. If you are using 3M DBM wire connectors, make sure the wires have not been stripped. Unlike other wire connectors on the market, DBMs are designed to cut through the insulation to make a water-resistant coupling without removing the insulation. Push the wires all the way into the wire connector. Be sure to crimp the black cap all the way down (gel should ooze out of the top) to ensure a water-resistant connection. Gently pull on the wires to make sure they are secure. If the insulation has been stripped, recut the wires and repeat the steps above.

**Problem:**            **Station does not start**

*Possible cause:*    No run time has been programmed for that station.

*Solution:*            Transmit a run time to the Control Module.

*Possible cause:*    The Rain-off Mode is activated (X on the sprinkler icon )

*Solution:*            Permit irrigation by deactivating the Rain-off Mode.

*Possible cause:*    Another station is in operation.

*Solution:*            Use the manual station option to turn off that station.

*Possible cause:*    The battery is weak.

*Solution:*            Replace the battery.

## Troubleshooting (Continued)

*Possible cause:* A wire connection is faulty.

*Solution:* If you are using King wire connectors, gently pull on the wires to make sure they are secure. If the wires are loose, cut the wires. Strip 0.5 in. (1.25 cm.) of the insulation off the wires. Twist the wires, then push the wires into a new King connector and twist the connector around the wires. Gently pull on the wires to make sure they are secure.

If you are using 3M DBM wire connectors, make sure the wires have not been stripped. Unlike other wire connectors on the market, DBMs are designed to cut through the insulation to make a water-resistant coupling without removing the insulation. Push the wires all the way into the wire connector. Be sure to crimp the black cap all the way down (gel should ooze out of the top) to ensure a water-resistant connection. Gently pull on the wires to make sure they are secure. If the insulation has been stripped, recut the wires and repeat the steps above.

*Possible cause:* The UNIK Rain Shut-off Device is wet.

*Solution:* Flip the UNIK Rain Shut-off Device switch to off. If you have an old style Control Module, cut the UNIK Rain Shut-off Device wires. Connect the black wires from the Control Module to the black field wires. Carry out a manual stop and then repeat the manual start.

**Problem: Station stops when it should start and vice versa**

*Possible cause:* The Control Module and solenoid wire connections are reversed.

*Solution:* Reconnect the red wires from the Control Modules to the red wires from the solenoids, then reconnect the black wires.

**Problem: Station 1 works, but the rest of the stations do not**

*Possible cause:* The underground UNIK Rain Shut-off Device is located in the zone watered by Station 1.

*Solution:* If possible, move the Rain Shut-off Device to the last irrigated zone or, better, outside the irrigated area altogether.

**WARNING:** This equipment has been tested and found to comply with the limits for a Class A digital device, pursuant to part 15 of the FCC Rules. These limits are designed to provide reasonable protection against harmful interference when the equipment is operated in a commercial environment. This equipment generates, uses and can radiate radio frequency energy and if not installed and used in accordance with the instruction manual, may cause interference to radio communications. Operation of this equipment in a residential area is likely to cause harmful interference in which case the user will be required to correct the interference at their own expense.

Changes or modifications not expressly approved by Rain Bird Sales, Inc. could void the user's authority to operate the equipment.



**Customer Support Center  
6640 S. Bonney Ave.  
Tucson, AZ 85706  
1-800-RAIN-BIRD  
(520) 434-6289 FAX**